

Glass Bottles

FLINT

AMBER

GREEN



← BOTTLES



Healthy Living



Catalogue(11), Sep 2012, v.1



We're Asia-Pacific wide

We operate in Malaysia, Indonesia, Singapore and Australia. We primarily work with small-medium enterprises in mid-size markets.



Catalogue(11), Sep 2012, v.1 *pl*

OUR TEAM

Availability of wide range of glass products from our own designs and those of our partnering plant. (ACI/OI background) provides design concepts and product specifications to enhance packaging designs. We design and develop new glass products and moulds.

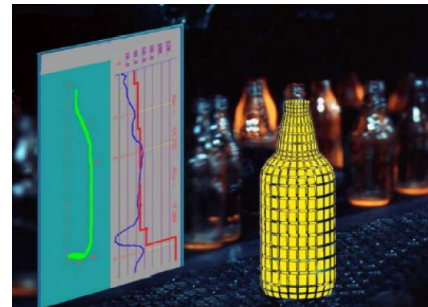

Understand your product and the appropriate packaging to help you add value to your products and profitability.

Understand your technical and quality requirement, work with partnering plants to ensure the glass packaging product meets to your requirement.

Implement strict Process Control and Quality Assurance systems to ensure quality products supplied, conform to the product specification.

Organizing prompt deliveries to your requirement, a relief from time spent on tracking suppliers and deliveries.

OUR VALUE

Low Entry Cost: e.g. mould cost US\$15k, minimum qty per order of 200,000 - 300,000 pcs.

Wide Range: from 10ml to 2 Litre, pharmaceuticals, food, beverage, wine, decorated and printed ware.

Flexibility: our existing and partnering plant in multiple manufacturing location.

Stability: multi-location manufacturing and dedicated production lines.

Consistent Quality: achievable standards and implement best practice procedures.

Improvement: in yield, efficiency, ultimately productivity .

Lightweight technology. Reduction in bottle weight results reduced trucking load hence distribution cost reduced by 5%.



We aim at developing a wide assistance network to offer a quick and qualified service in order to build customer satisfaction and loyalty.

Contact Us

Class Bottles under 300ml

www.glaspak.com.my
+603 - 7847 3276 / 5276

LIMITED

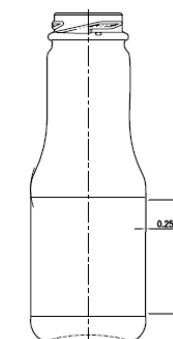
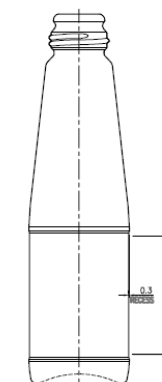
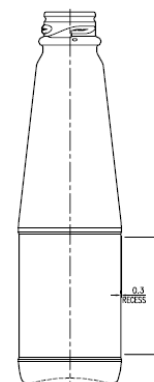
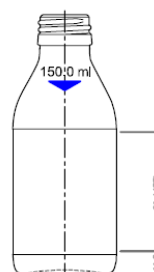
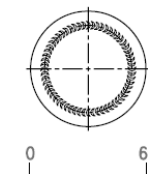
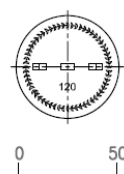

250
200
150
100
50
mm

PRODUCT	GP1023
BRIMFUL (ml)	140.0
WEIGHT (g)	110
HEIGHT (mm)	98.5
BODY (mm)	52.3
FINISH TYPE	38 SCREW
PCS/TRAY	481
LAYERS	11 / 10
PCS/PALLET	5291 / 4810
COLOUR	AMBER

PRODUCT	GP1139
BRIMFUL (ml)	160.0
WEIGHT (g)	160
HEIGHT (mm)	132.4
BODY (mm)	53.0
FINISH TYPE	28 SROTE
PCS/TRAY	420
LAYERS	15
PCS/PALLET	6300
COLOUR	AMBER

PRODUCT	GP1079
BRIMFUL (ml)	226.0
WEIGHT (g)	200
HEIGHT (mm)	190.0
BODY (mm)	52.5
FINISH TYPE	30 MTO Snap
PCS/TRAY	462
LAYERS	12
PCS/PALLET	5544
COLOUR	FLINT

PRODUCT	GP1006B
BRIMFUL (ml)	222.0
WEIGHT (g)	185
HEIGHT (mm)	190.0
BODY (mm)	51.2
FINISH TYPE	26/31 CSS
PCS/TRAY	500
LAYERS	12
PCS/PALLET	6000
COLOUR	FLINT

PRODUCT	W966 GP1009C
BRIMFUL (ml)	250.0
WEIGHT (g)	187
HEIGHT (mm)	167.5
BODY (mm)	59.0
FINISH TYPE	38 RTO
PCS/TRAY	371
LAYERS	7 / 6
PCS/PALLET	2597 / 2226
COLOUR	FLINT



BOTTLES < 300ml
CATALOGUE(10), MAY 2011
SIZE A4, SCALE 1:4

Contact Us

Class Bottles above 300ml

www.glaspak.com.my
+603 - 7847 3276 / 5276

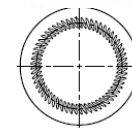
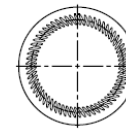
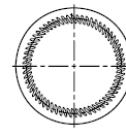

0 60

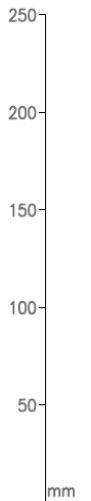
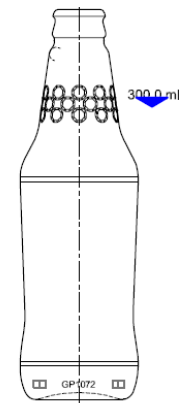
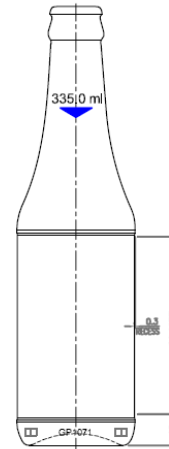
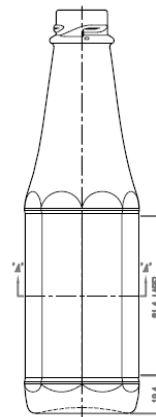

PRODUCT GP1002C	
BRIMFUL (ml)	311.0
WEIGHT (g)	185
HEIGHT (mm)	206.7
BODY (mm)	58.7
FINISH TYPE	30 MTO
PCS/TRAY	410
LAYERS	6
PCS/PALLET	2460
COLOUR	FLINT

PRODUCT GP1035	
BRIMFUL (ml)	315.0
WEIGHT (g)	240
HEIGHT (mm)	223.0
BODY (mm)	59.8
FINISH TYPE	28 SCREW
PCS/TRAY	385
LAYERS	5
PCS/PALLET	1925
COLOUR	FLINT

PRODUCT GP1071	
BRIMFUL (ml)	354.0
WEIGHT (g)	195
HEIGHT (mm)	225.0
BODY (mm)	60.6
FINISH TYPE	26-600
PCS/TRAY	371
LAYERS	5
PCS/PALLET	1855
COLOUR	FLT / AMB

PRODUCT GP1072	
BRIMFUL (ml)	327.0
WEIGHT (g)	185
HEIGHT (mm)	200.0
BODY (mm)	60.5
FINISH TYPE	26-655
PCS/TRAY	371
LAYERS	6
PCS/PALLET	2226
COLOUR	FLINT



BOTTLES > 300ml
CATALOGUE(10), MAY 2011
SIZE A4, SCALE 1:4

Contact Us

Class Bottles above 500ml

www.glaspak.com.my
+603 - 7847 3276 / 5276

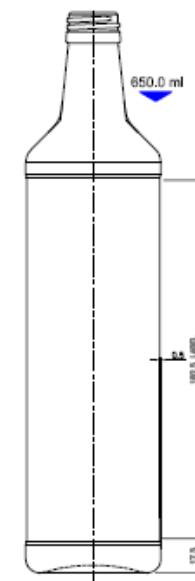
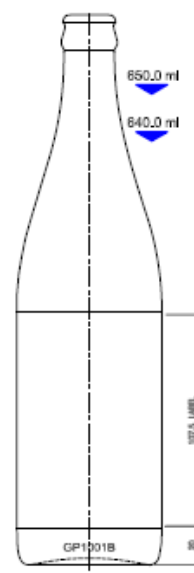
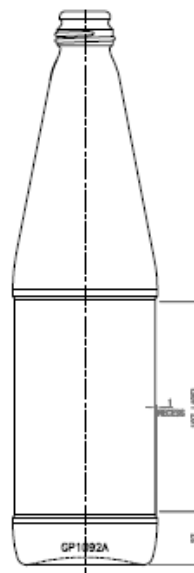
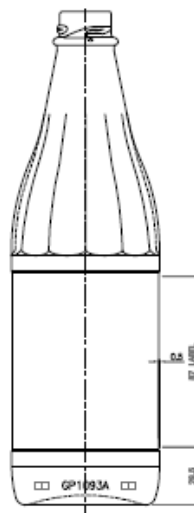
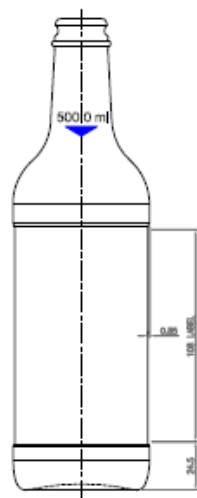
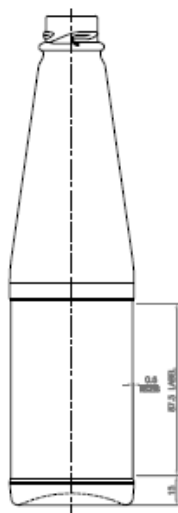
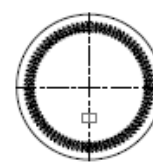
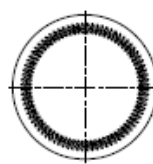
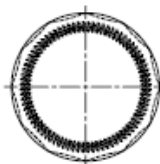
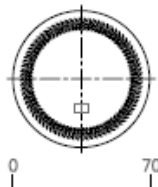
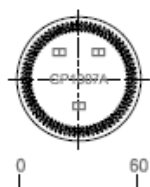

PRODUCT	GP1007A
BRIMFUL (ml)	455.0
WEIGHT (g)	280
HEIGHT (mm)	250.0
BODY (mm)	63.3
FINISH TYPE	30 MTO
PCS/TRAY	341
LAYERS	5
PCS/PALLET	1705
COLOUR	FLINT

PRODUCT	GP1110
BRIMFUL (ml)	526.0
WEIGHT (g)	290
HEIGHT (mm)	240.0
BODY (mm)	69.5
FINISH TYPE	26 SNAP
PCS/TRAY	264
LAYERS	5 / 4
PCS/PALLET	1320 / 1056
COLOUR	FLINT

PRODUCT	GP1093A
BRIMFUL (ml)	635.0
WEIGHT (g)	420
HEIGHT (mm)	251.2
BODY (mm)	75.4
FINISH TYPE	30 MTO
PCS/TRAY	233
LAYERS	5 / 4
PCS/PALLET	1165 / 932
COLOUR	FLINT

PRODUCT	GP1092
BRIMFUL (ml)	671.0
WEIGHT (g)	440
HEIGHT (mm)	282.0
BODY (mm)	73.5
FINISH TYPE	26/31 CSS
PCS/TRAY	240
LAYERS	8
PCS/PALLET	1920
COLOUR	FLINT

PRODUCT	GP1001 TG185
BRIMFUL (ml)	659.0
WEIGHT (g)	430
HEIGHT (mm)	280.0
BODY (mm)	74.0
FINISH TYPE	26-600
PCS/TRAY	240
LAYERS	8
PCS/PALLET	1920
COLOUR	FLT / AMB

PRODUCT	GP1108
BRIMFUL (ml)	663.0
WEIGHT (g)	435
HEIGHT (mm)	285.5
BODY (mm)	68.8
FINISH TYPE	28 SROTE
PCS/TRAY	276
LAYERS	8
PCS/PALLET	2208
COLOUR	FLINT



BOTTLES > 500ml
CATALOGUE(10), MAY 2011
SIZE A4, SCALE 1:4

Contact Us

Class Bottles above 750ml

www.glaspak.com.my
+603 - 7847 3276 / 5276

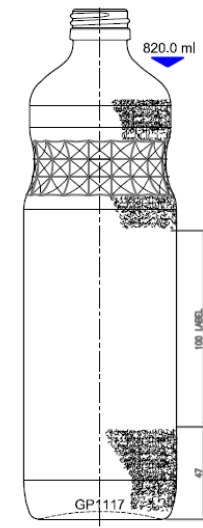
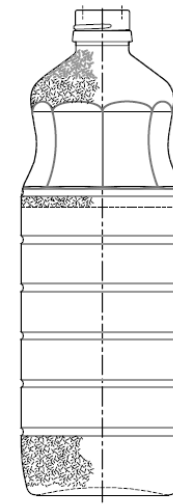
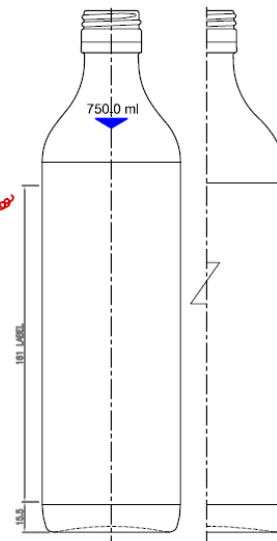
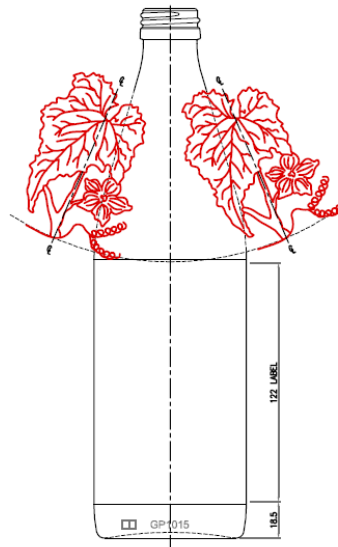
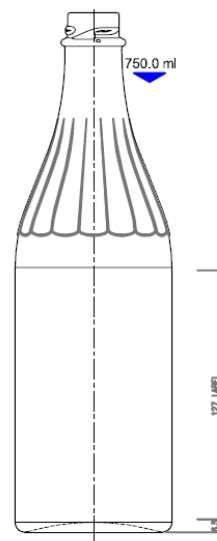
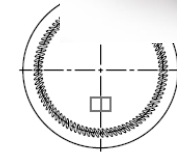
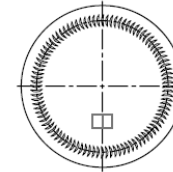
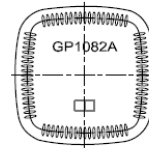
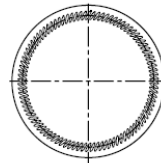
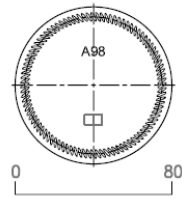

PRODUCT	A098 GP1098
BRIMFUL (ml)	768.0
WEIGHT (g)	430
HEIGHT (mm)	265.0
BODY (mm)	80.0
FINISH TYPE	30 MTO
PCS/TRAY	208
LAYERS	4
PCS/PALLET	612
COLOUR	FLINT

PRODUCT	GP1015
BRIMFUL (ml)	769.0
WEIGHT (g)	450
HEIGHT (mm)	270.0
BODY (mm)	77.7
FINISH TYPE	31.5 SROTE
PCS/TRAY	225
LAYERS	4
PCS/PALLET	900
COLOUR	FLINT

PRODUCT	GP1082
BRIMFUL (ml)	784.0
WEIGHT (g)	465
HEIGHT (mm)	266.0
BODY (mm)	70.5 x 70.5
FINISH TYPE	31.5 PPF
PCS/TRAY	238
LAYERS	8
PCS/PALLET	1904
COLOUR	FLINT

PRODUCT	A112
BRIMFUL (ml)	855.0
WEIGHT (g)	550
HEIGHT (mm)	247.3
BODY (mm)	82.6
FINISH TYPE	30 SNAP
PCS/TRAY	182
LAYERS	9
PCS/PALLET	1638
COLOUR	FLINT

PRODUCT	GP1117
BRIMFUL (ml)	835.0
WEIGHT (g)	505
HEIGHT (mm)	260.0
BODY (mm)	78.5
FINISH TYPE	31.5 SROTE
PCS/TRAY	210
LAYERS	9
PCS/PALLET	1890
COLOUR	FLINT



BOTTLES > 750ml
CATALOGUE(10), MAY 2011
SIZE A4, SCALE 1:4

Contact Us

Square Bottles

150ml-250ml

www.glaspak.com.my
+603 - 7847 3276 / 5276

LIMITED

LIMITED

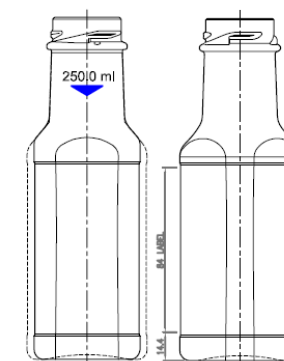
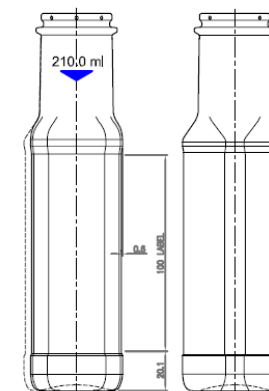
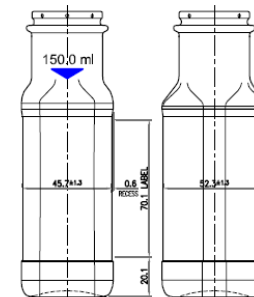
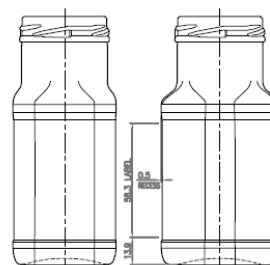
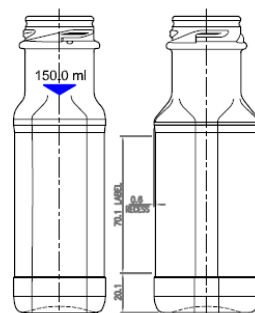
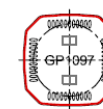
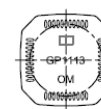

PRODUCT	GP1025
BRIMFUL (ml)	171.0
WEIGHT (g)	183
HEIGHT (mm)	151.1
BODY (mm)	46.9 x 46.9
FINISH TYPE	38 MTO
PCS/TRAY	525
LAYERS	6
PCS/PALLET	3150
COLOUR	FLINT

PRODUCT	GP1027
BRIMFUL (ml)	203.0
WEIGHT (g)	170
HEIGHT (mm)	126.6
BODY (mm)	52.8 x 52.8
FINISH TYPE	48 RTO
PCS/TRAY	418
LAYERS	8
PCS/PALLET	3344
COLOUR	FLINT

PRODUCT	GP1113
BRIMFUL (ml)	166.0
WEIGHT (g)	190
HEIGHT (mm)	145.6
BODY (mm)	46.9 x 46.9
FINISH TYPE	36/29 Bericap
PCS/TRAY	525
LAYERS	6
PCS/PALLET	3150
COLOUR	FLINT

PRODUCT	GP1097
BRIMFUL (ml)	225.0
WEIGHT (g)	228
HEIGHT (mm)	192.5
BODY (mm)	46.9 x 46.9
FINISH TYPE	36/29 Bericap
PCS/TRAY	528
LAYERS	5
PCS/PALLET	2640
COLOUR	FLINT

PRODUCT	GP1061
BRIMFUL (ml)	266.0
WEIGHT (g)	237
HEIGHT (mm)	174.6
BODY (mm)	54.0 x 54.0
FINISH TYPE	38 MTO
PCS/TRAY	396
LAYERS	6
PCS/PALLET	2376
COLOUR	FLINT



BTLS SQUARES
CATALOGUE(10), MAY 2011
SIZE A4, SCALE 1:4

Contact Us

Liquor Bottles under 500ml

www.glaspak.com.my
+603 - 7847 3276 / 5276

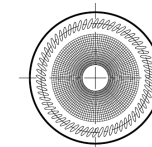
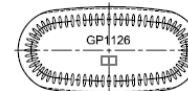
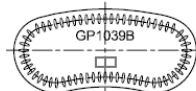

0 50

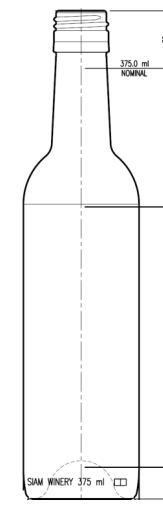
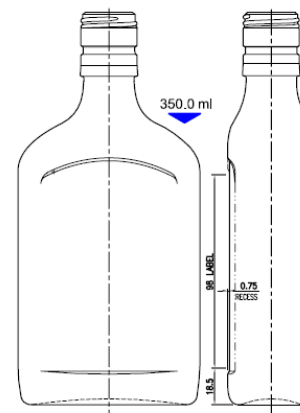
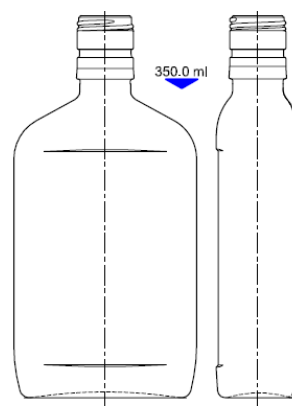
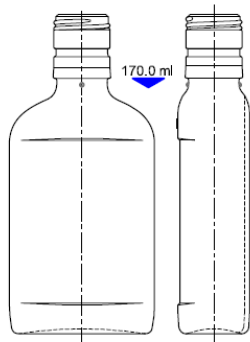
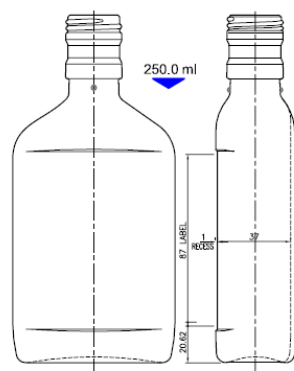
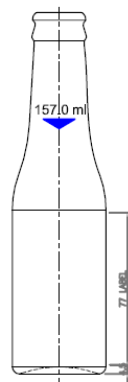

200
150
100
50
mm

PRODUCT	GP1078
BRIMFUL (ml)	178.0
WEIGHT (g)	125
HEIGHT (mm)	183.0
BODY (mm)	47.4
FINISH TYPE	26-655
PCS/TRAY	600
LAYERS	6
PCS/PALLET	3600
COLOUR	FLINT

PRODUCT	GP1122
BRIMFUL (ml)	260.0
WEIGHT (g)	250
HEIGHT (mm)	176.0
BODY (mm)	82.0 x 40.5
FINISH TYPE	30 EDROTE
PCS/TRAY	391
LAYERS	12
PCS/PALLET	4692
COLOUR	FLINT

PRODUCT	GP1033
BRIMFUL (ml)	182.6
WEIGHT (g)	202
HEIGHT (mm)	150.0
BODY (mm)	73.5 x 36.3
FINISH TYPE	30 EDROTE
PCS/TRAY	525
LAYERS	13
PCS/PALLET	6825
COLOUR	FLINT

PRODUCT	GP1039
BRIMFUL (ml)	365.0
WEIGHT (g)	310
HEIGHT (mm)	193.5
BODY (mm)	92.5 x 42.5
FINISH TYPE	30 EDROTE
PCS/TRAY	330
LAYERS	12
PCS/PALLET	3960
COLOUR	FLINT

PRODUCT	GP1126
BRIMFUL (ml)	365.0
WEIGHT (g)	345
HEIGHT (mm)	198.5
BODY (mm)	92.0 x 44.0
FINISH TYPE	30 EDROTE
PCS/TRAY	288
LAYERS	11
PCS/PALLET	3168
COLOUR	FLINT

PRODUCT	CY375LZL
BRIMFUL (ml)	383.0
WEIGHT (g)	345
HEIGHT (mm)	255.0
BODY (mm)	60.0
FINISH TYPE	30/60
PCS/TRAY	361
LAYERS	9
PCS/PALLET	3249
COLOUR	Dark.Green



LIQUORS < 500ml
CATALOGUE(10), MAY 2011
SIZE A4, SCALE 1:4

Contact Us

www.glaspak.com.my
+603 - 7847 3276 / 5276

Liquor Bottles above 500ml

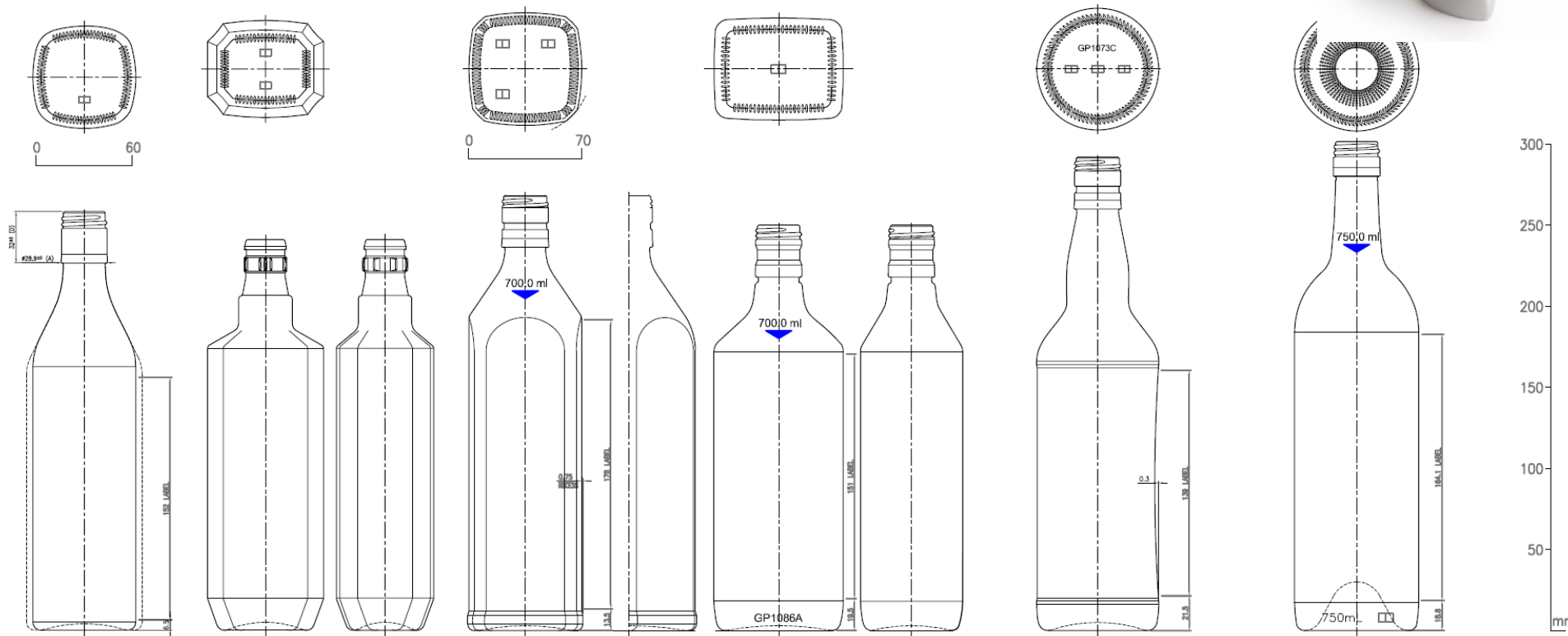

PRODUCT	A525
BRIMFUL (ml)	537.0
WEIGHT (g)	450
HEIGHT (mm)	262.0
BODY (mm)	64.0 x 64.0
FINISH TYPE	30/32 ROLL-ON
PCS/TRAY	304
LAYERS	9
PCS/PALLET	2736
COLOUR	FLINT

PRODUCT	GP1127
BRIMFUL (ml)	537.0
WEIGHT (g)	450
HEIGHT (mm)	241.0
BODY (mm)	71.5 x 60.0
FINISH TYPE	26 GUALA
PCS/TRAY	247
LAYERS	8
PCS/PALLET	1976
COLOUR	FLINT

PRODUCT	FK1111
BRIMFUL (ml)	723.0
WEIGHT (g)	450
HEIGHT (mm)	268.4
BODY (mm)	69.5 x 69.5
FINISH TYPE	30 EDROTE
PCS/TRAY	240
LAYERS	7
PCS/PALLET	1680
COLOUR	FLINT

PRODUCT	GP1086A
BRIMFUL (ml)	730.0
WEIGHT (g)	470
HEIGHT (mm)	260.0
BODY (mm)	79.0 x 60.0
FINISH TYPE	30 EDROTE
PCS/TRAY	247
LAYERS	8
PCS/PALLET	1976
COLOUR	FLINT

PRODUCT	GP1073 TG307
BRIMFUL (ml)	720.0
WEIGHT (g)	420
HEIGHT (mm)	292.0
BODY (mm)	75.3
FINISH TYPE	30 EDROTE
PCS/TRAY	232
LAYERS	8
PCS/PALLET	1856
COLOUR	FLINT

PRODUCT	750-5LK
BRIMFUL (ml)	770.0
WEIGHT (g)	545
HEIGHT (mm)	301.5
BODY (mm)	76.5
FINISH TYPE	30/60 BVS
PCS/TRAY	225
LAYERS	8
PCS/PALLET	1800
COLOUR	Antique Grn



LIQUORS > 500ml
CATALOGUE(10), MAY 2011
SIZE A4, SCALE 1:4

Contact Us

Twist Off:

Roll-On:

Snap-On:

Crown Seal:

www.glaspak.com.my
+603 - 7847 3276 / 5276



30-MTO

38-RTO

28x18

30x35

30x60

32x24 c/w pourer

26mm Guala CF4409

26mm Crown Seal

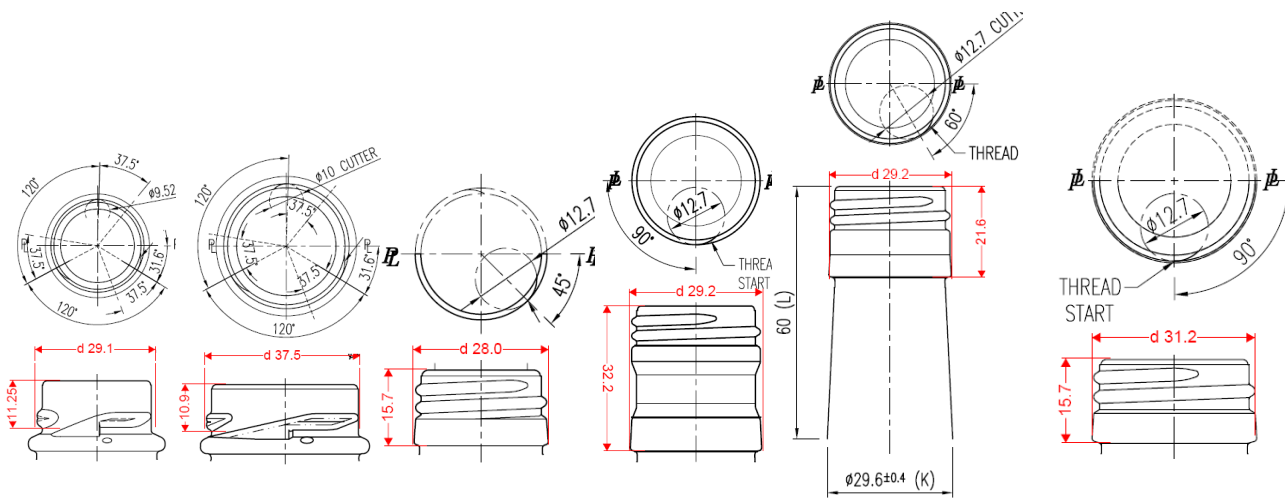

Twist Off: 30mm

38mm

22~28mm

30mm EDROTE

30/60 BVS

32mm SROTE

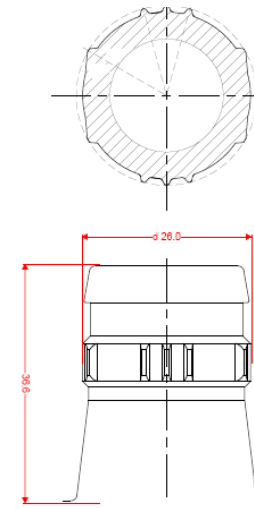

Guala Snap

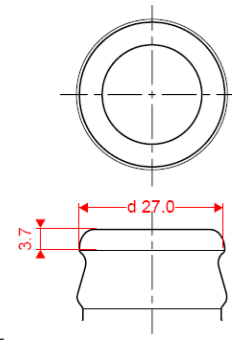

26-600